

K500 & Paddle Wheel User Manual

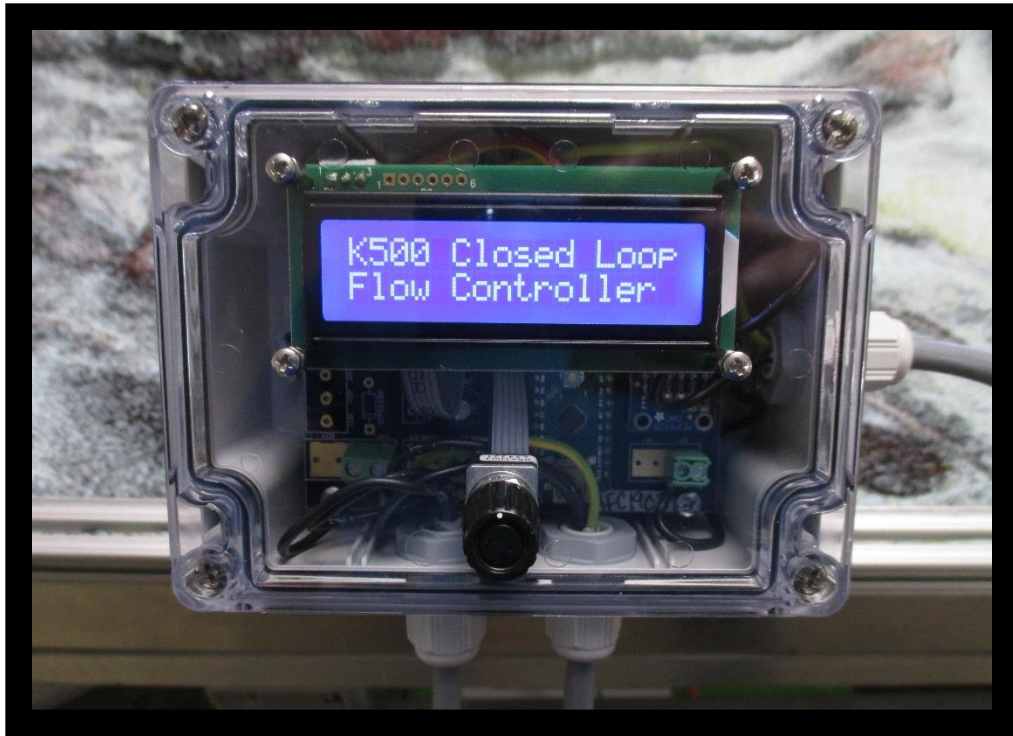

550 N. University Ave.
Carbondale, Illinois, USA
phone +1.618.529.7423
info@emriver.com
www.emriver.com



Introduction

Your Emriver K500 digital flow controller can provide precise measurement of flow rates from 25 ml/sec to 210 ml/sec and automatically run hydrographs. Setup and use are largely the same for every Emriver model.

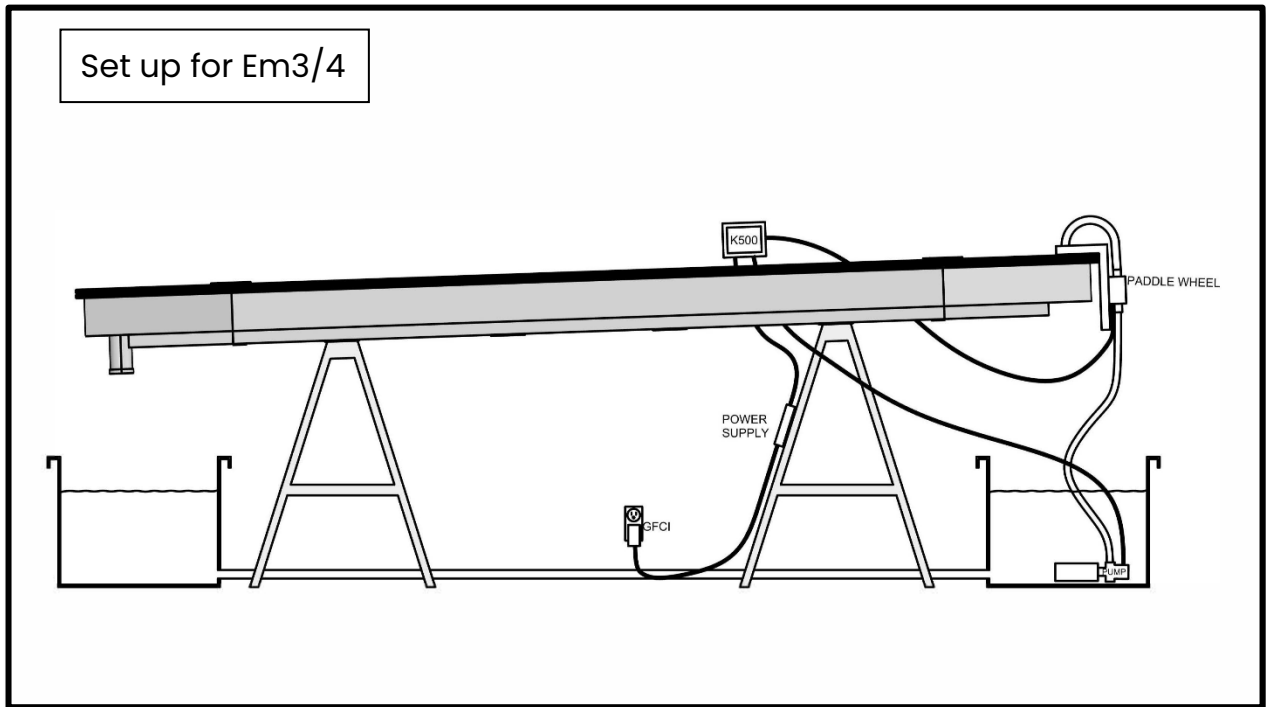
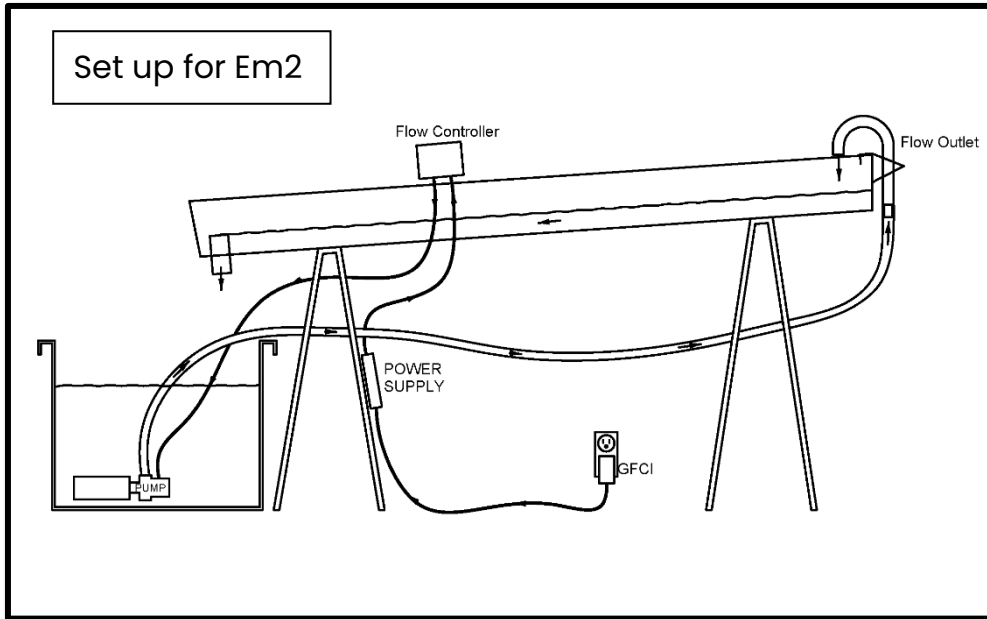

1. Mount the K500 controller on the stream table box

On an Em2, the controller is mounted on the left-hand side of the box when facing down stream, near the downstream support. On an Em3 or Em4, place the controller on the right-hand side of the box, near the upstream support. Place the claw mount over the edge of the box and tighten Screw 1 so that the bracket is secure. Screw 2 can be used to adjust the viewing angle of the K500. If you need to remove the K500 from the mounting bracket, just loosen Screw 2 until the balls are removable from their sockets.

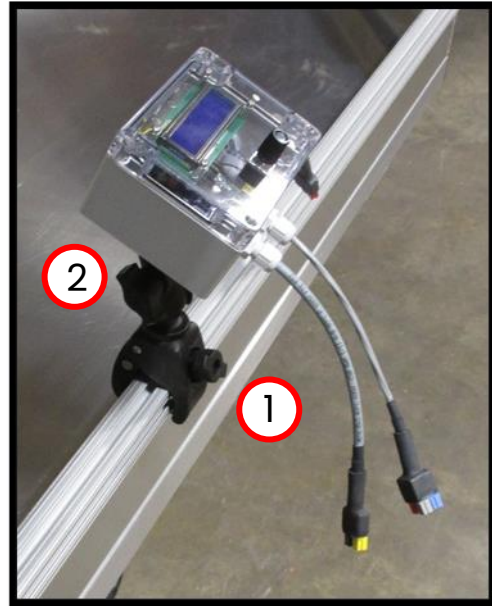

2. Mount the paddle wheel assembly

Hang the paddle wheel assembly in the center of the upstream end of the box. The position of the outlet hose end may be adjusted by loosening the thumbscrews on the top bracket.

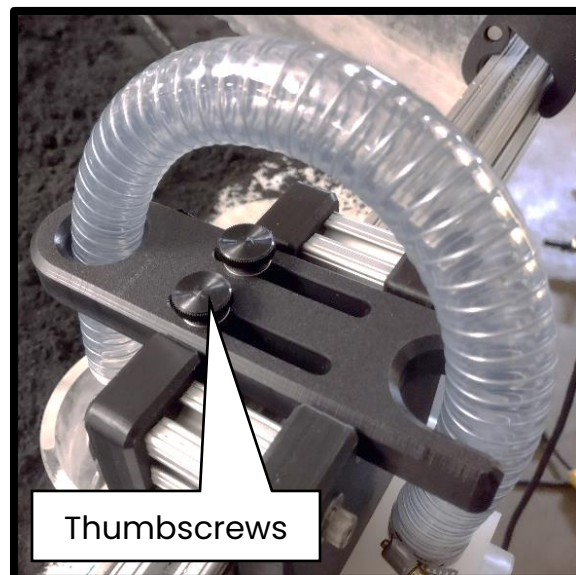
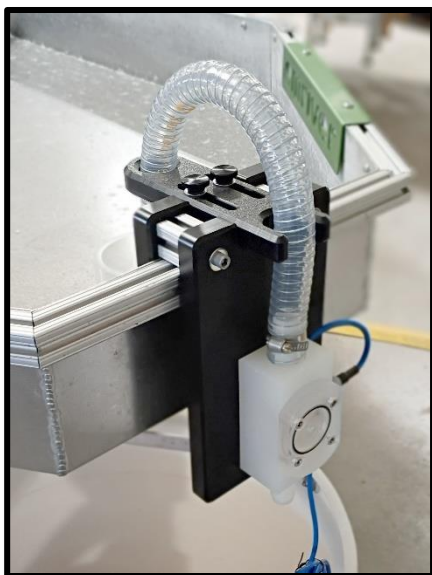

3. Connect tubing to pump and paddle wheel

If you are replacing another flow controller with the K500 and GRI pump, first remove the long flexible PVC tubing from your existing acrylic outlet and pump. Attach one end of the tubing to the barb connector on the bottom of the paddle wheel and one end to the GRI pump using the enclosed hose clamps.

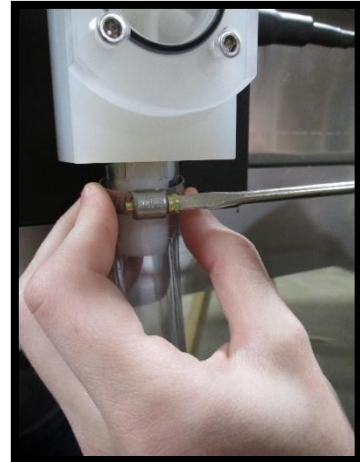
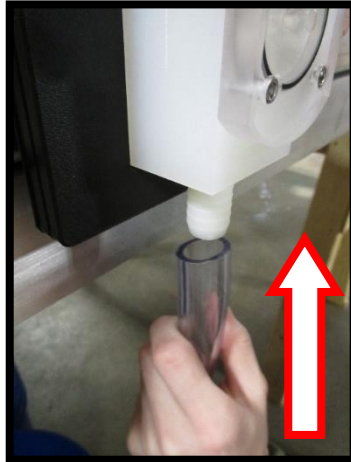

Attach the filter to the pump and be sure to fill the reservoir with water before powering up the K500 controller. The pump *must* be fully submerged before being operated.

4. Make electrical connections

The K500 controller has three electrical connectors.

Make the power connection last, and make sure there is water in the reservoir before you start the pump using the controller. An LED on the circuit board will light up when the controller is receiving power.

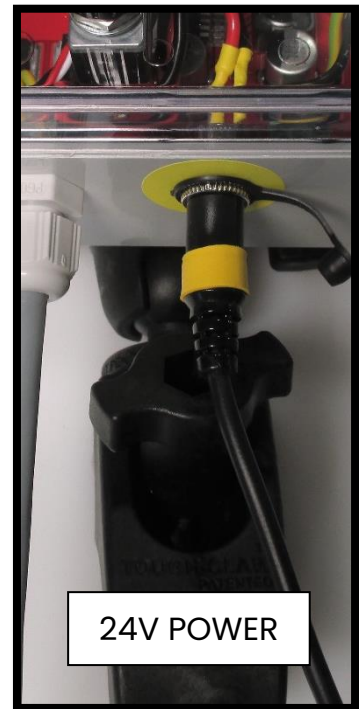
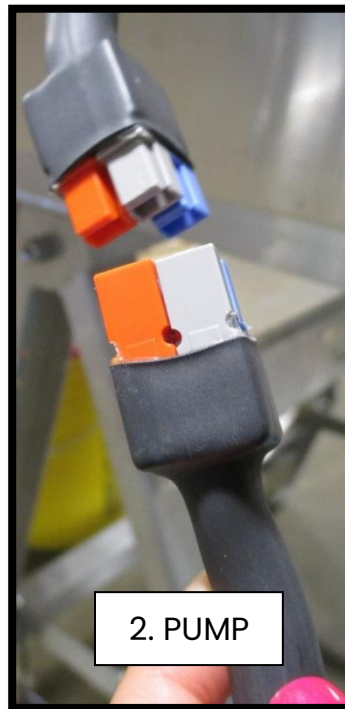
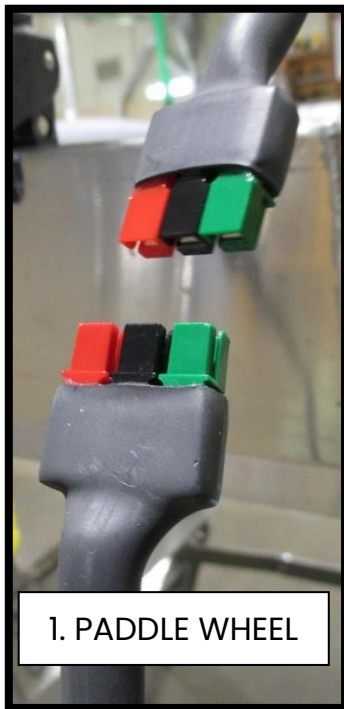
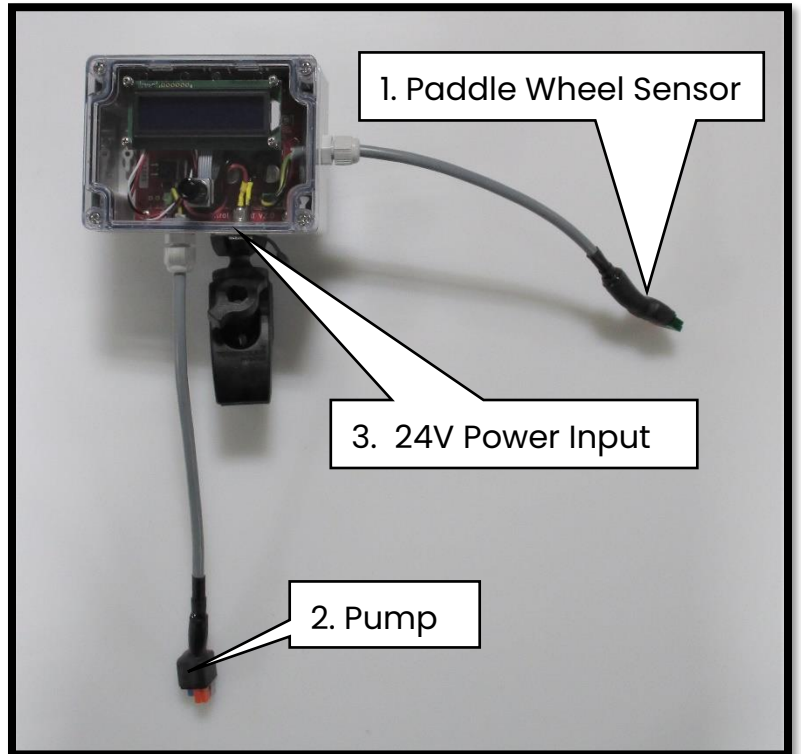

5. K500 Operation

Upon startup, the K500 will briefly display two splash screens and then go to the home display where the timer will immediately start.

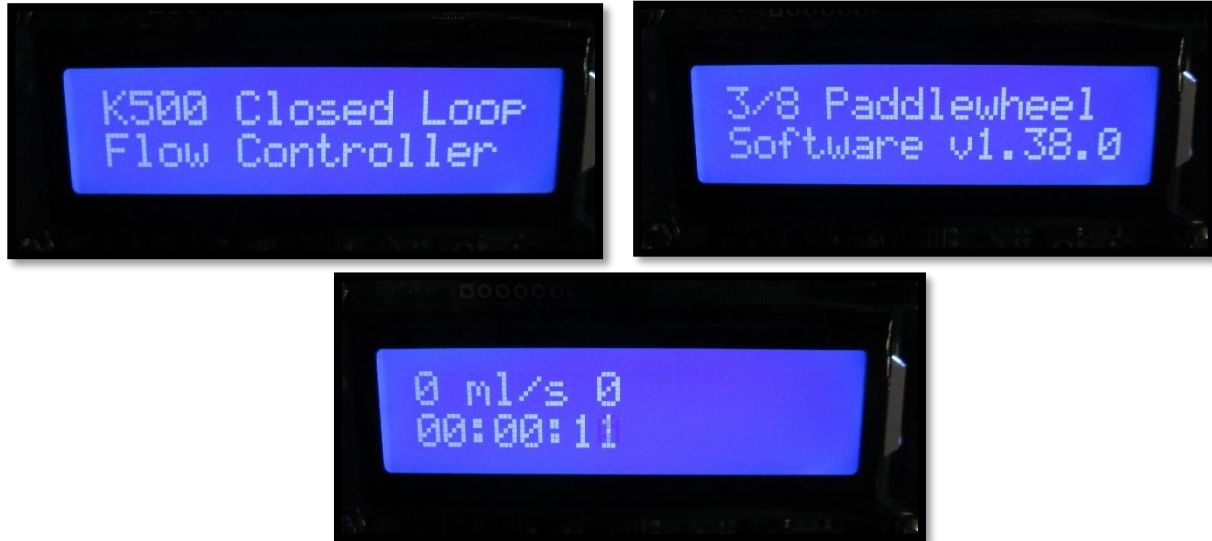

Home Screen

The home screen provides the user with five indicators.

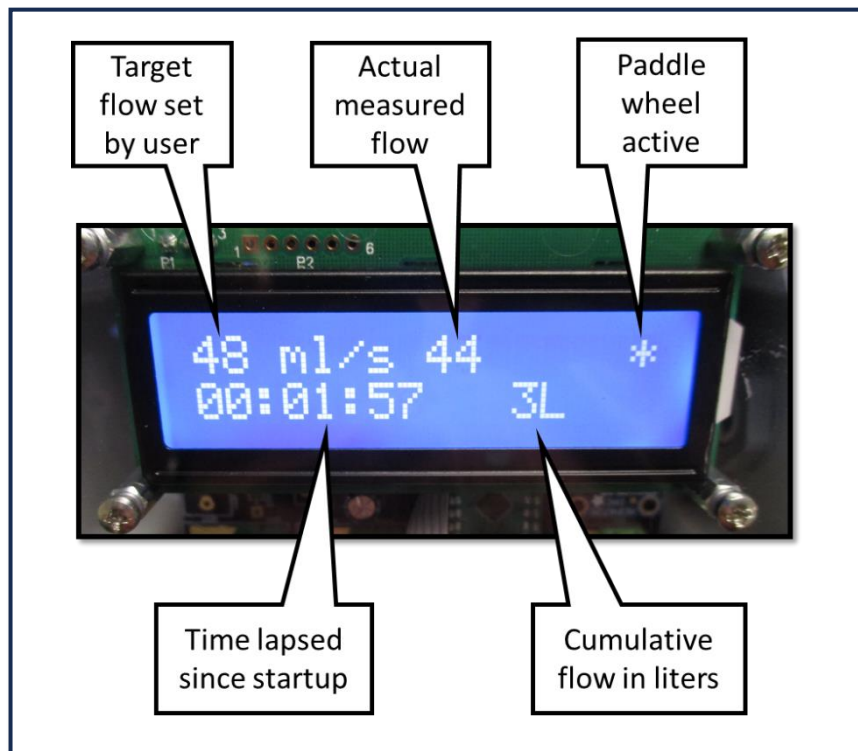

While at the home screen, turn the knob clockwise to start flow. The lowest setting is 25 ml/sec. You may need to set a higher flow rate when you are first starting up the system to flush air from the tubing or filter. Agitating the filter with the pump assembly under water can help remove air.

After setting a target flow, it will take a little time for the pump to stabilize the flow around the target. The range of flow is from 25 ml/sec to 210 ml/sec.

Error Statement

If the K500 does not detect input from the paddle wheel for 30 seconds, either because the sensor is disconnected or there is no flow from the pump, an error indicator will appear on the home screen.

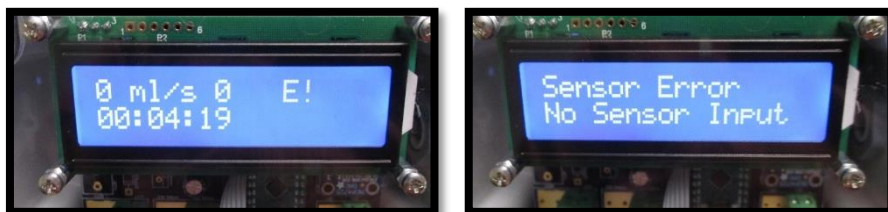

If you receive an error statement, first check the electrical connection from the paddle wheel to the K500. If the connection is OK, check to see whether there is air in the filter or tubing preventing the pump from priming or getting flow to the paddle wheel. Reset the K500 by disconnecting the power supply and reconnecting.

Note that if the sensor is disconnected, the pump will continue to run for 30 seconds before shutting off automatically. In some circumstances, particularly when the flow rate is above 100 ml/s, the pump speed will ramp up to its maximum rate until the connection is reestablished or the pump shuts off.

Navigating the Menu Screens

Press the knob once to display the **Menu Selector** screen.



Turn the knob one 'click' to the right to get the **Zero Flow** screen. Here you can **press** the knob once to stop all flow.



Turn the knob again to get the **Maximize Flow** screen. Here you can **press** the knob once to set the flow to the maximum level, 210 ml/sec.



Turn the knob again to get the **Hydrograph Selector** screen.

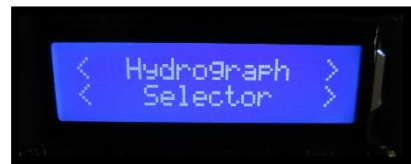

Here you can **press** the knob once to enter the submenu of Hydrograph options. **Turn** the knob to cycle through the options. **Press** the knob to select and start a hydrograph. When the hydrograph is complete, flow will return to zero. **Press** the knob during a hydrograph to stop flow.

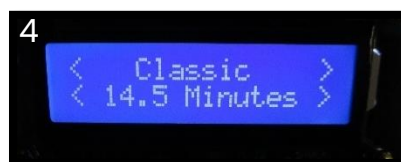

Press the knob on the **Back** screen to go back to the main **Hydrograph Selector**.



This chart shows the timing and flow rates of preprogrammed hydrographs on K500.

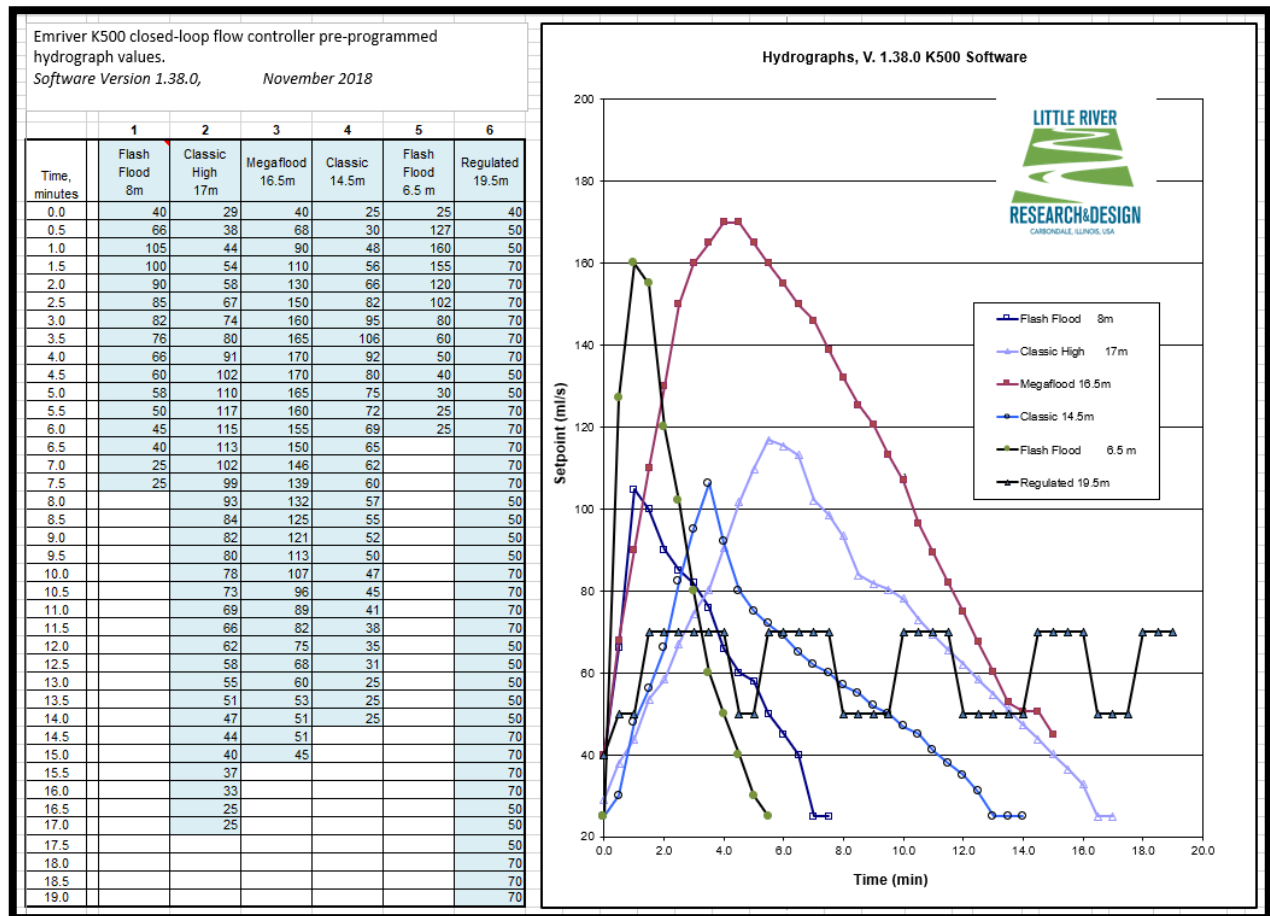

Turn the knob to view the **Controller Information** screen. Here you can **press** the knob to view information.

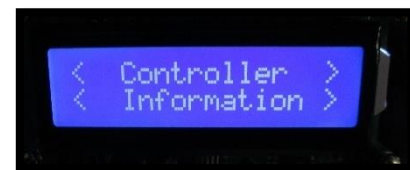

Turn the knob to return to the **Main Screen**.

6. Powering Down

To power down when finished, simply unplug the power cord on the K500. The controller should be powered down after each use.

Troubleshooting

Problem	Recommendations
<p>Display is dark</p>	<p>If the LED on the circuit board in the controller is not illuminated and there is no display on the LCD, there is no power to the controller.</p>
	<p>Check that all connections are firm and that GFCI adapter is not tripped.</p>
	<p>Make sure correct power adapter (24V, 3.75A) is being used. There is a yellow band on the DC barrel jack to indicate correct size.</p>
	<p>If none of these work, call Emriver for assistance.</p>
<p>Controller is on but no water is moving or water starts to flow begins but an E (ERROR) is displayed on the LED</p>	<p>Ensure four-color connector is firm between pump and controller.</p>
	<p>Inspect metal tabs in the four-color connector for corrosion.</p>
	<p>Air in the line is the most common reason for the delay in flow. Ensure pump and filter are fully submerged. Air trapped in the filter or pump can prevent the pump from priming. A clogged filter can trap air. If the water in the reservoir is clean, you can remove the filter while submerged to help purge air and prime the pump.</p>
	<p>If the pump is fully submerged, and there is a hum, but no flow, turn off the power and follow the steps in "Cleaning the GRI Pump" included in your manual. Grit in the impeller could prevent it from spinning properly.</p>

	<p>If water reaches the flow meter but the paddle does not rotate, turn off the power, detach the inlet and outlet hoses on the paddle wheel and flush the flow meter in a sink by running clean water through both the inlet and outlet.</p>
	<p>If none of these work, call Emriver for assistance.</p>
<p>Water flow is erratic</p>	<p>Some fluctuation around the setpoint is normal. Rapid changes to flow rate will require up to 20 seconds to settle.</p>
	<p>If the head (the height difference between the water level in the reservoir and the outlet) is changed rapidly, the pump may fluctuate for a short time before settling around the set point.</p>
	<p>If you lower the setpoint down to zero and then quickly turn it back to a low flow rate, it can take up to 30 seconds to settle back at the new rate.</p>
	<p>If the flow cannot seem to settle, call Emriver for assistance.</p>

For questions or troubleshooting beyond this manual, please see our website, emriver.com, or call Emriver, Inc. at 618-529-7423.

The manual for the Omega FPR301 paddle wheel can be viewed at <https://www.omega.com/Manuals/manualpdf/M4172.pdf>